

# Hydrostatic Pump Repair

www.hydrostaticpumprepair.net

Phone: 800-361-0028

Email: sales@hydrostatic-transmission.com

**Rexroth**  
Bosch Group

## Proportional pressure relief valve, pilot operated

**RE 29258/11.11** 1/20  
Replaces: RE 29158

### Types (Z)DBE and (Z)DBEE

Size 6  
Component series 2X  
Maximum operating pressure 350 bar  
Maximum flow 30 l/min

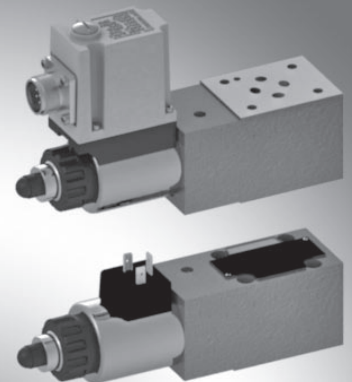

### Table of contents

Contents	Page
Features	1
Ordering code	2
Symbols	2
Function, cross-section	3, 4
Technical data	5, 6
Accessories	7
Electrical connection, mating connectors	8
Integrated electronics (OBE) on types DBiEE and ZDBEE	9
Characteristic curves	10 to 16
Unit dimensions	17, 18

### Features

- Pilot operated valve for limiting a system pressure
- Operation by means of proportional solenoids
- Proportional solenoid with rotatable and detachable coil
- For subplate mounting or sandwich plate design:  
Porting pattern according to ISO 4401-03-02-0-05  
and DIN 24340
- Valve and control electronics from a single source
- External control electronics for types DBE and ZDBE
- Linear command value pressure characteristic curve
- Types DBEE and ZDBEE with integrated electronics (OBE):
  - Low manufacturing tolerance of the command value pressure characteristic curve

Information on available spare parts:  
[www.boschrexroth.com/spc](http://www.boschrexroth.com/spc)

### Ordering code

	DBE		6		2 - 2X /		G24			*
--	-----	--	---	--	----------	--	-----	--	--	---

Subplate mounting = no code  
 Sandwich plate = Z

Proportional pressure relief valve

for external control electronics = no code  
 with integrated electronics (OBE) = E

Size 6 = 6

Subplate mounting = no code  
 Pressure limitation in channel P = VP

Preferred position of mating connector = 2

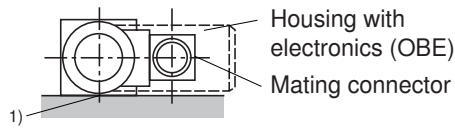

The mating connector can be brought to the desired position after the nut was loosened (see page 17, 18).

1) Valve mounting face (seal ring recesses in the housing)

Component series 20 to 29 = 2X  
 (20 to 29: Unchanged installation and connection dimensions)

#### Maximum setting pressure

Pressure rating 25 bar	= 25
Pressure rating 50 bar	= 50
Pressure rating 100 bar	= 100
Pressure rating 200 bar	= 200
Pressure rating 315 bar	= 315
Pressure rating 350 bar	= 350

Further details in plain text

#### Seal material

M = NBR seals  
 V = FKM seals

#### Interface electronics

A1 = Command value 0 to 10 V  
 F1 = Command value 4 to 20 mA  
 no code = for (Z)DBE

#### Electrical connection

##### for DBE; ZDBE:

K4 = without mating connector, with connector according to DIN EN 175301-803  
 Mating connector – separate order see page 8

##### for DBEE; ZDBEE:

K31 = without mating connector, with connector according to DIN EN 175201-804  
 Mating connector – separate order see page 8

#### Supply voltage

G24 = +24 V direct voltage

no code = Pilot oil return, internal (recommendation: Subplate mounting up to  $Q_{Vmax} = 15$  l/min)

Y = Pilot oil return, external (only possible with subplate mounting)

### Symbols (for sandwich plate symbol: ① = component side, ② = plate side)

Type DBE 6...

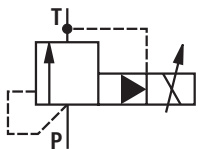

Type DBE 6...Y..

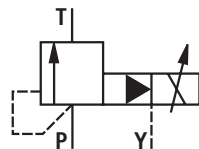

Type ZDBE 6 VP...

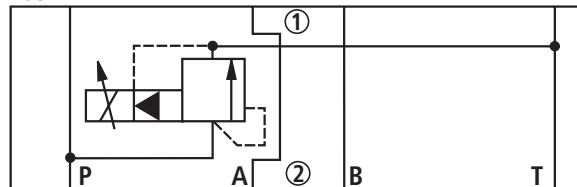

Type DBEE 6...

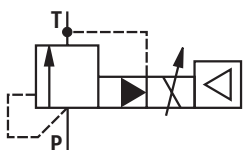

Type DBEE 6...Y..

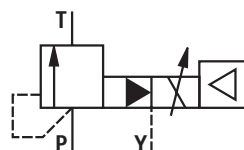

Type ZDBEE 6 VP...

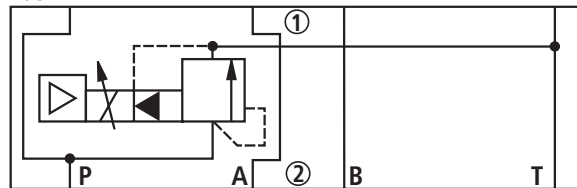

## Function, cross-section

### Types DBE and ZDBE

The pilot operated proportional pressure relief valves of the types DBE and ZDBE are operated by means of a proportional solenoid. These valves are used to limit a system pressure. With these valves it is possible to steplessly adjust the system pressure to be limited depending on the electrical command value.

These valves basically consist of a pilot control stage and a main stage.

The pilot control stage consists of a proportional solenoid (1), the poppet (2) and the valve seat (3). The main stage consists of a housing (4) and the main spool cartridge assembly (5). The proportional solenoid proportionally converts the electrical current into a mechanical force. An increase in the current intensity causes a corresponding rise in the magnetic force. The system pressure is adjusted by means of the proportional solenoid (1) depending on the command value. Pressure applied by the system in port P acts on the right hand side of the main spool cartridge assembly (5). At the

same time, the system pressure acts via the pilot line (7), which is provided with a nozzle (6), on the spring-loaded side of the spool.

Via the valve seat in the pilot line (3), the pressure at the poppet (2) in the spring chamber acts against the force of the proportional solenoid (1).

Once the pressure has reached the pre-set value, the poppet (3) is lifted from the seat. The pilot oil can now (depending on the model) drain externally via port A (Y) or internally into the tank, which results in a limitation of the pressure on the spring-loaded side of the main spool (5). If the system pressure continues to rise slightly, the higher pressure on the right hand side of the spool will push the spool to the left into the control position P to T.

At a minimum control current (corresponds to a command value of zero), the minimum setting pressure will be set.

### Notice!

- The tank lines should be prevented from running empty. If corresponding installation conditions are provided, a pre-charge valve (pre-charging pressure approx. 1 bar) is to be installed.

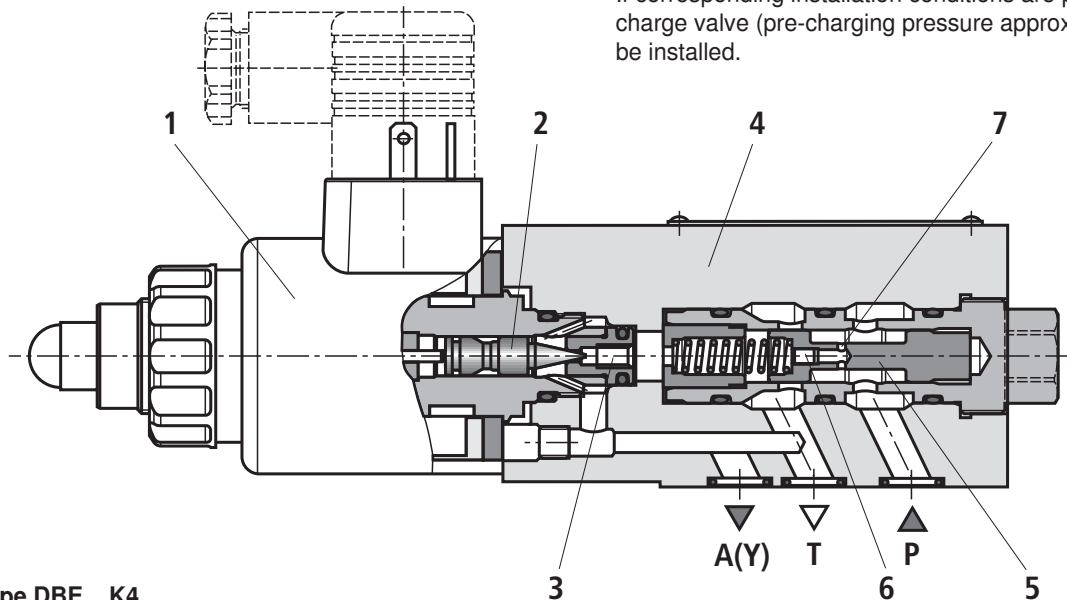

Type DBE ...K4...

## Function, cross-section

---

### Type (Z)DBEE – with integrated electronics (OBE)

In terms of function and design, these valves correspond to type (Z)DBE. An additional housing (10) is fitted on the proportional solenoid which accommodates the control electronics.

Supply and command value voltage are applied at the connector (11).

In the factory, the command value pressure characteristic curve is adjusted with little manufacturing tolerance.

For more information on the control electronics, see page 9.

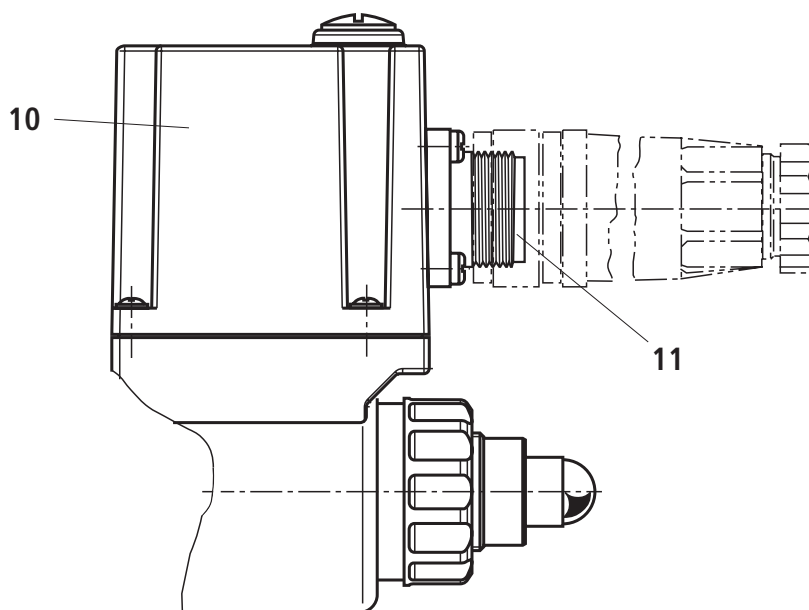

Type (Z)DBEE...-2X/...YG24K31...

**Technical data** (For applications outside these parameters, please consult us!)**general**

Weight	- DBE and ZDBE	kg	2.4
	- DBEE and ZDBEE	kg	2.5
Installation position			Any
Storage temperature range		°C	-20 to +80
Ambient temperature range	- DBE and ZDBE	°C	-20 to +70
	- DBEE and ZDBEE	°C	-20 to +50

**hydraulic** (measured with HLP 46;  $\vartheta_{oil} = 40 \text{ °C} \pm 5 \text{ °C}$ )

Maximum operating pressure	- Port P; P1 – P2 A1 – A2; B1 – B2	bar	350
	- Port T	bar	50
Maximum setting pressure	- Pressure rating 25 bar	bar	25
	- Pressure rating 50 bar	bar	50
	- Pressure rating 100 bar	bar	100
	- Pressure rating 200 bar	bar	200
	- Pressure rating 315 bar	bar	315
	- Pressure rating 350 bar	bar	350
Minimum setting pressure at command value 0		bar	See characteristic curves on page 14 and 15
Return flow pressure in port A; with external pilot oil return (Y)			Separately at zero pressure to the tank
Pilot flow		l/min	0.6 to 1.2
Maximum flow		l/min	30
Hydraulic fluid			See table page 6
Hydraulic fluid temperature range		°C	-20 to +80
Viscosity range		mm <sup>2</sup> /s	15 to 380
Maximum admissible degree of contamination of the hydraulic fluid cleanliness class according to ISO 4406 (c)			Class 20/18/15 <sup>1)</sup>
Hysteresis		%	±3 of the maximum setting pressure
Repeatability		%	< ±2 of the maximum setting pressure
Linearity		%	±3.5 of the maximum setting pressure
Manufacturing tolerance of the command value pressure characteristic curve, related to the hysteresis characteris- tic curve, pressure increasing	- DBE and ZDBE	%	±5 of the maximum setting pressure
	- DBEE and ZDBEE	%	±1.5 of the maximum setting pressure
Step response $T_u + T_g$ at $Q_v = 5 \text{ l/min}$	10 % → 90 %	ms	130
	90 % → 10 %	ms	110

] Depending on system

<sup>1)</sup> The cleanliness classes specified for the components must be complied with in hydraulic systems. An effective filtration prevents faults and at the same time increases the service life of the components.

For the selection of the filters see [www.boschrexroth.com/filter](http://www.boschrexroth.com/filter).

**Technical data** (For applications outside these parameters, please consult us!)**hydraulic**

Hydraulic fluid	Classification	Suitable sealing materials	Standards
Mineral oils and related hydrocarbons	HL, HLP	NBR, FKM	DIN 51524
Environmentally compatible	– Insoluble in water	HEES	ISO 15380
		HEPR	
	– Soluble in water	HEPG	ISO 15380
Flame-resistant	– Water-free	HFDU, HFDR	ISO 12922
	– Water-containing	HFC Fuchs Hydrotherm 46M Petrofer Ultra Safe 620	ISO 12922

<p> <b>Important information on hydraulic fluids!</b></p> <ul style="list-style-type: none"> <li>– For more information and data on the use of other hydraulic fluids refer to data sheet 90220 or contact us!</li> <li>– The flash point of the process and operating medium used must be 40 K higher than the maximum solenoid surface temperature.</li> </ul>	<p><b>– Flame-resistant – water-containing:</b></p> <p>Maximum pressure differential 210 bar, otherwise increased cavitation erosion! The pressure peaks should not exceed the maximum operating pressures!</p> <p>Service life as compared to HLP 30 - 100 %</p> <p>Maximum fluid temperature 60 °C</p>
--	--



**electric**

Minimum solenoid current	mA	≤ 100
Maximum solenoid current	mA	1600 ± 10 %
Solenoid coil resistance	Cold value at 20 °C	Ω 5.5
	Maximum hot value	Ω 8.05
Duty cycle	%	100

**electrical, integrated electronics (OBE)**

Supply voltage	Nominal voltage	VDC	24
	Lower limit value	VDC	21
	Upper limit value	VDC	35
Current consumption	A	≤ 1.5	
Required fuse protection	A	2, time-lag	
Inputs	Voltage	V	0 to 10
	Current	mA	4 to 20
Output	Actual current value	mV	1 mV △ 1 mA
Protection class of the valve according to EN 60529			IP 65 with mating connector mounted and locked

**Accessories** (not included in scope of delivery)

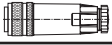
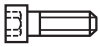
<b>Proportional amplifier for type (Z)DBE</b> 		<b>Material number</b>
VT-MSPA1-11-1X/ in modular design	according to data sheet 30223	
VT-VSPD-2 in eurocard format	according to data sheet 30523	
VT-MSPA1-11-1X/ in eurocard format	according to data sheet 30100	
VT-SSPA1-1-1X plug-in amplifier	according to data sheet 30116	
<b>Mating connector for type (Z)DBE</b> 		<b>Material number</b>
Mating connector (black)	according to DIN EN 175301-803	R901017011
<b>Mating connector for type (Z)DBEE</b> 		<b>Material number</b>
Mating connector	according to DIN EN 175201-804	e.g. R900021267 (plastic)
		e.g. R900223890 (metal)
<b>Hexagon socket head cap screws</b> 		<b>Material number</b>
Type DBE(E)	4x ISO 4762 - M5 x 50 - 10.9-flZn-240h-L (friction coefficient $\mu_{\text{total}} = 0.09$ to $0.14$ ) Tightening torque $M_A = 7 \text{ Nm} \pm 10 \%$	
Type ZDBE(E)	4x ISO 4762 - M5 - 10.9-flZn-240h-L (friction coefficient $\mu_{\text{total}} = 0.09$ to $0.14$ ) Tightening torque $M_A = 7 \text{ Nm} \pm 10 \%$	

**Notice:** The tightening torque of the hexagon head cap screws refers to the maximum admissible operating pressure!

<b>Subplates</b>	<b>Data sheet</b>
Size 6	45052

### Electrical connection (dimensions in mm)

#### (Z)DBE

Connection to connector

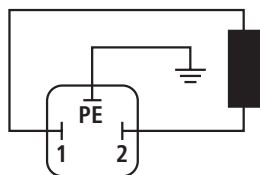

Connection to mating connector

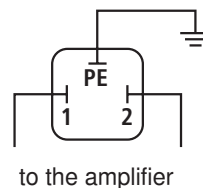

Mating connector (black)  
according to DIN EN 175301-803  
Material no. **R901017011**  
(separate order)

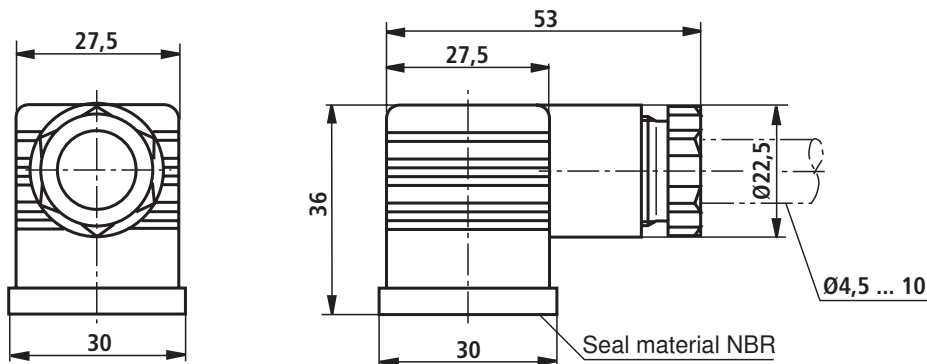

#### (Z)DBEE

Device connector allocation	Contact	Assignment interface "A1"	Assignment interface "F1"
Supply voltage	A	24 VDC ( $u(t) = 21 \text{ V to } 35 \text{ V}$ ); $I_{\text{max}} \leq 1.5 \text{ A}$	
	B	0 V	
Reference potential actual value	C	Reference contact F; 0 V	Reference contact F; 0 V
Differential amplifier input	D	0 to 10 V; $R_E = 100 \text{ k}\Omega$	4 to 20 mA; $R_E = 100 \Omega$
	E	Reference potential command value	
Measuring output (actual value)	F	0 to 1.6 V actual value ( $1 \text{ mV} \triangleq 1 \text{ mA}$ ) Load resistance > 10 k $\Omega$	
	PE	Connected to solenoid and valve housing	

Mating connectors according to DIN EN 175201-804, solder contacts for line cross-section 0.5 to 1.5 mm<sup>2</sup>

Plastic version,  
material no. **R900021267**,  
(separate order)

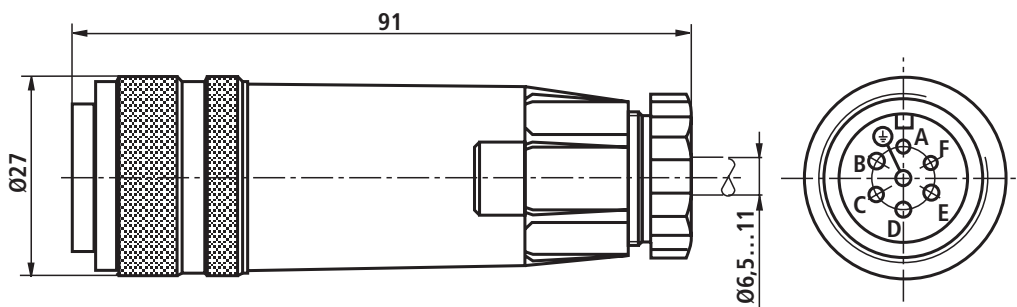

Metal version,  
material no. **R900223890**,  
(separate order)

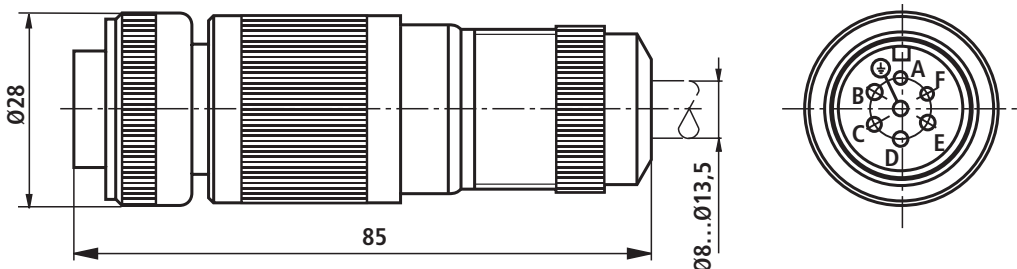



## Electrical connection

### Connection cable for (Z)DBEE

- Recommendation: 6-wire, 0.75 or 1 mm<sup>2</sup> plus protective earthing conductor and screening
- Only connect the screening to PE on the supply side
- Max. admissible length 100 m

The minimum supply voltage at the power supply unit depends on the length of the supply line (see diagram).

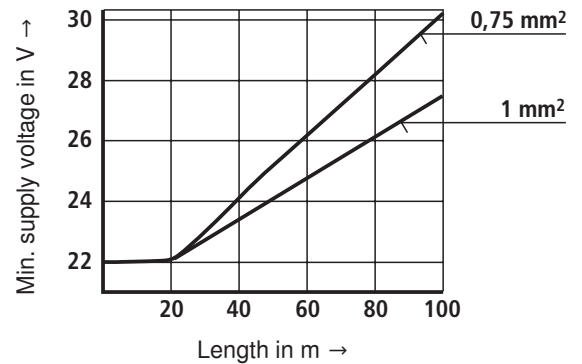

## Integrated electronics (OBE) for type (Z)DBEE

### Function

The electronics are supplied with voltage via ports A and B. The command value is applied to the differential amplifier ports D and E.

Via the characteristic curve generator, the command value solenoid current characteristic curve is adjusted to the valve so that non-linearities in the hydraulic system are compensated for and a linear command value pressure characteristic curve is created.

The current controller controls the solenoid current independent of the solenoid coil resistance.

The power section of the electronics for controlling the proportional solenoid is a chopper amplifier with a cycle frequency of approx. 180 Hz to 400 Hz. The output signal is pulse-width modulated (PWM).

For checking the solenoid current, a voltage can be measured between pin F(+) and pin C(-) that is proportional to the solenoid current. **1 mV** corresponds to a solenoid current of **1 mA**.

### Block diagram

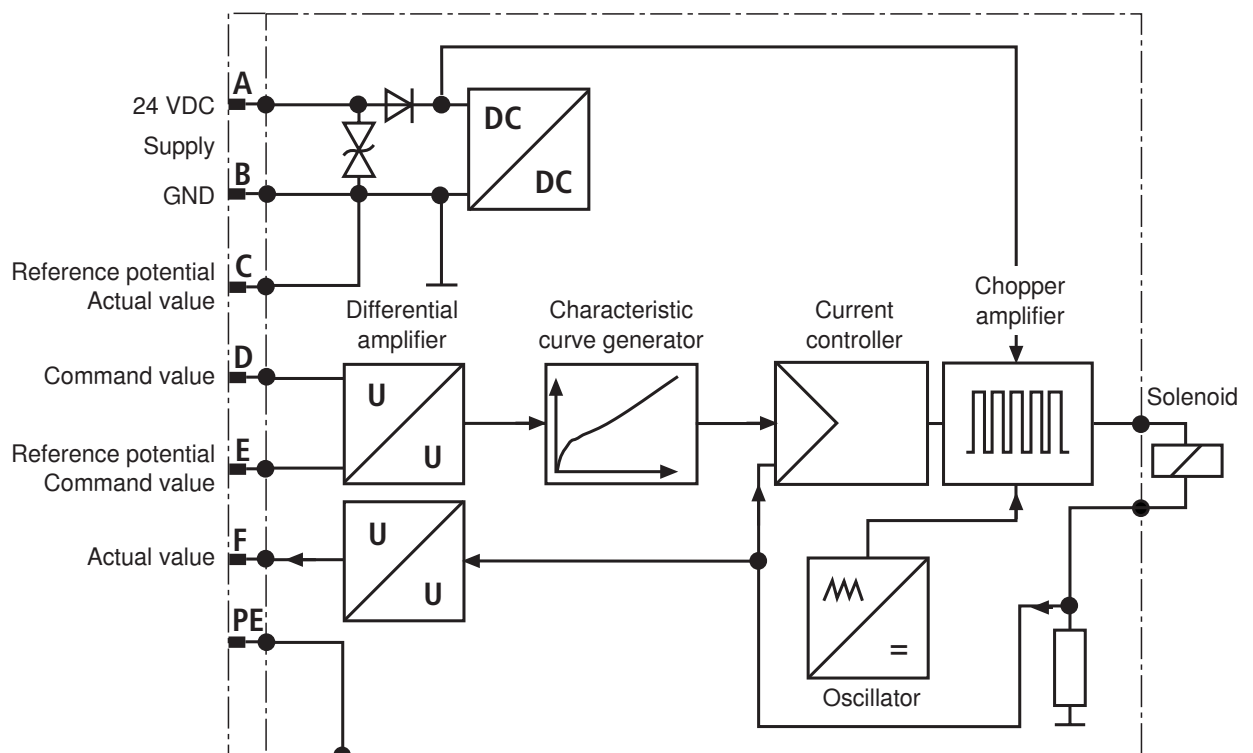

## Characteristic curves (measured with HLP46, $\vartheta_{oil} = 40 \text{ }^\circ\text{C} \pm 5 \text{ }^\circ\text{C}$ )

Pressure in port P depending on the command value ( $Q_V = 5 \text{ l/min}$ )

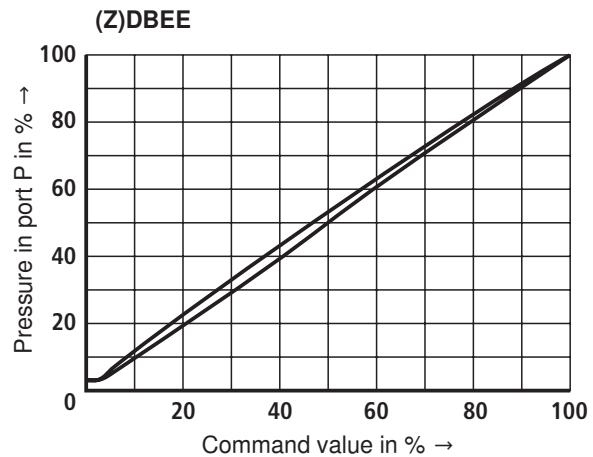
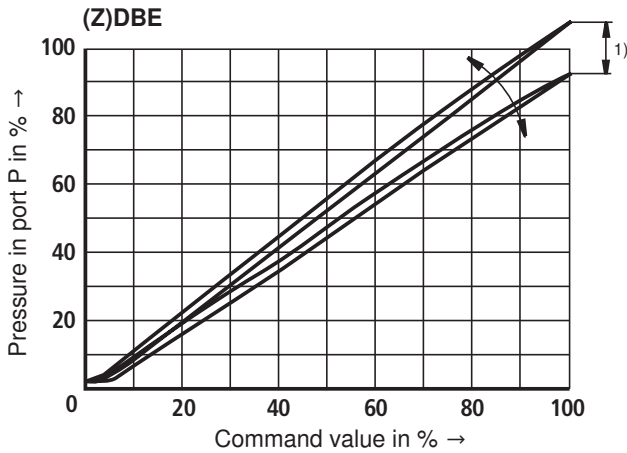

<sup>1)</sup> On valve DRE(M), the manufacturing tolerance can be adjusted at the **external analog amplifier** (for type and data sheet see page 7) using the command value attenuator potentiometer "Gw". The digital amplifier can be set by means of the parameter "limit".

Here, the control current according to the technical data must not be exceeded.

In order to match several valves to the same characteristic curve, at a command value of 100 %, the pressure must not exceed the maximum setting pressure of the relevant pressure rating at no valve.

Pressure in port P or P2 depending on the command value ( $Q_V = 5 \text{ l/min}$ )

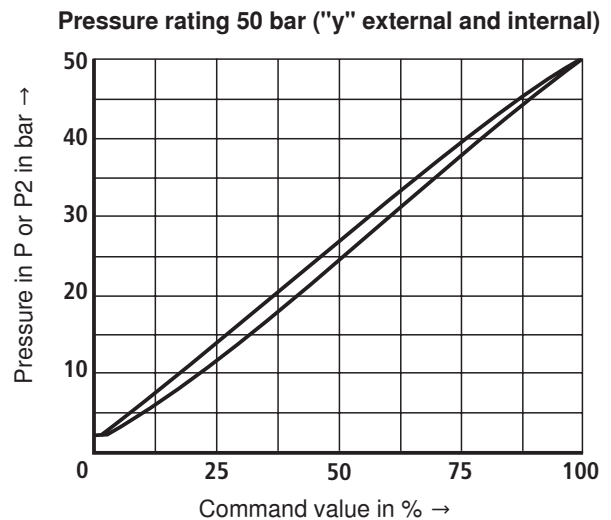
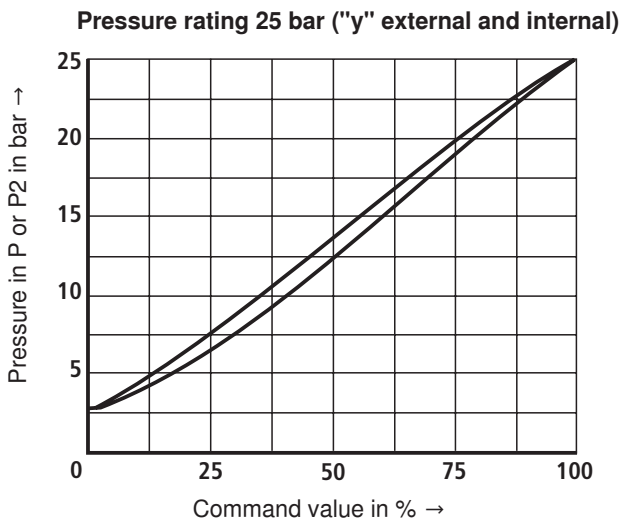

## Characteristic curves (measured with HLP46, $\vartheta_{oil} = 40 \text{ }^\circ\text{C} \pm 5 \text{ }^\circ\text{C}$ )

Pressure rating 100 bar ("y" external and internal)

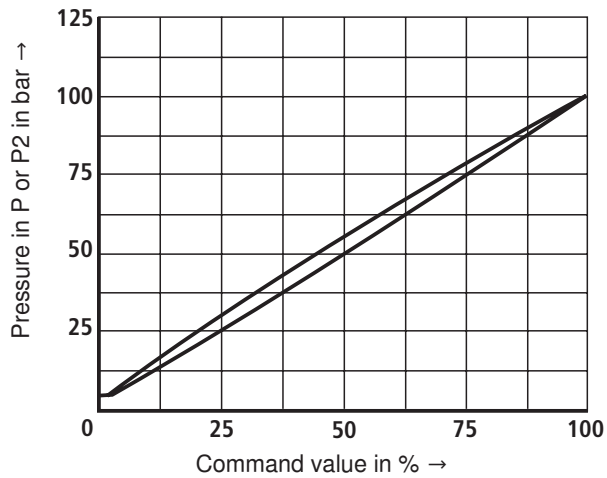

Pressure rating 200 bar ("y" external and internal)

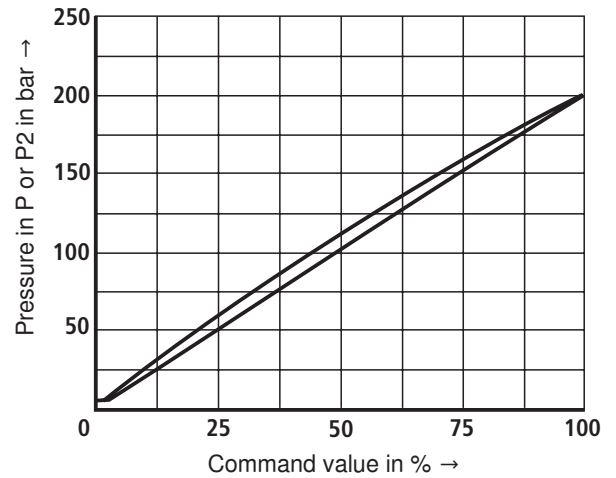

Pressure rating 315 bar ("y" external and internal)

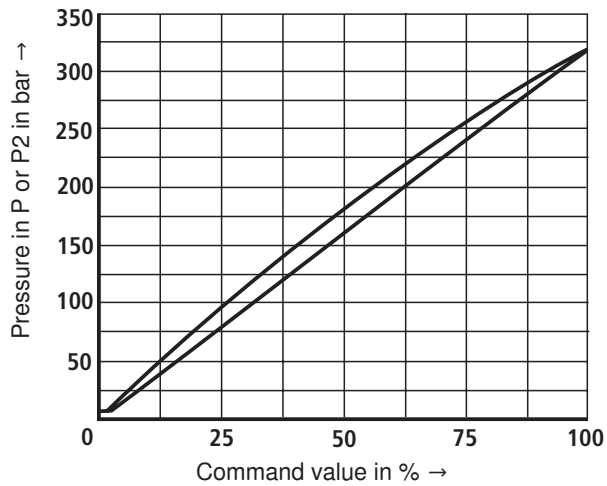

Pressure rating 350 bar ("y" external and internal)

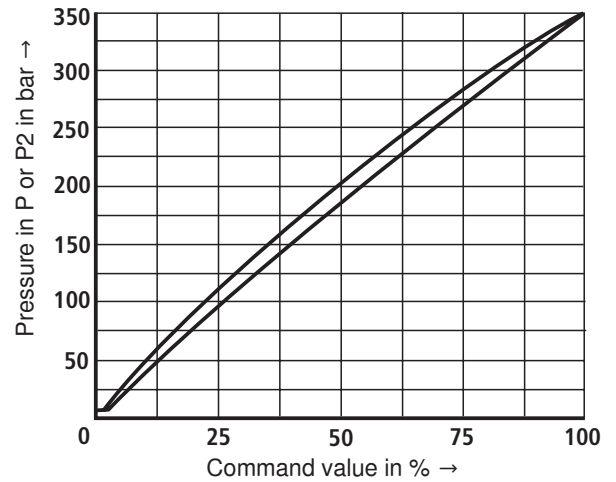

Pressure rating 200 bar (with VT-SSPA1) plug-in amplifier

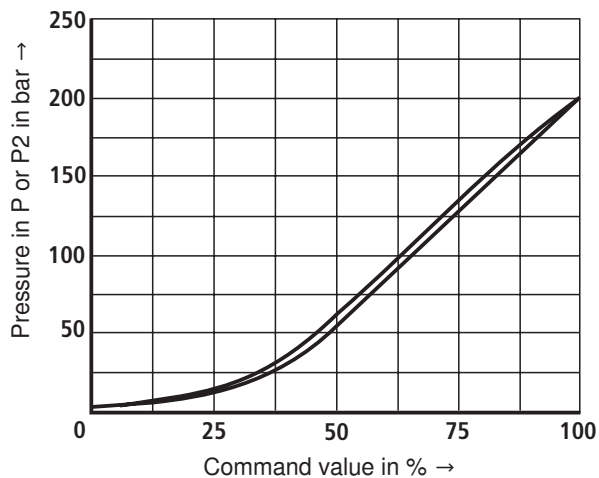

**Characteristic curves** (measured with HLP 46;  $\dot{\vartheta}_{oil} = 40 \text{ }^\circ\text{C} \pm 5 \text{ }^\circ\text{C}$ )

Pressure in channel P or P2 depending on the flow  $Q_v$   
 Pressure rating 25 bar

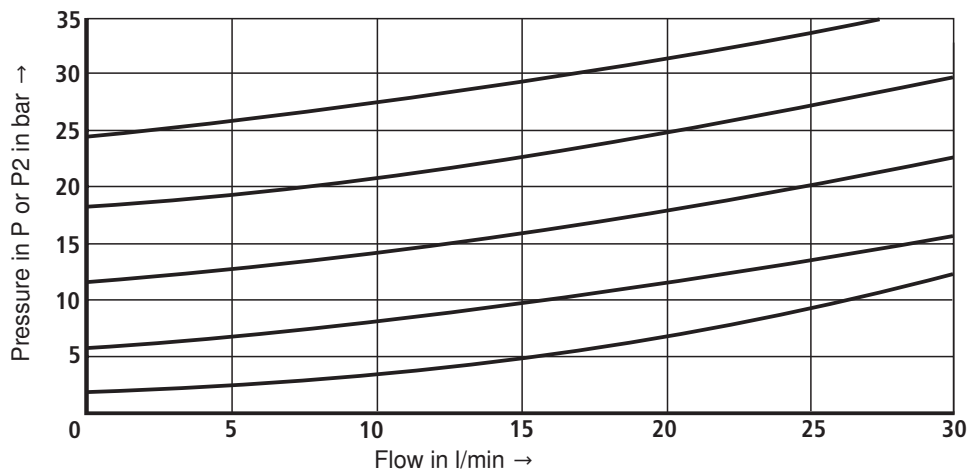

Pressure rating 50 bar

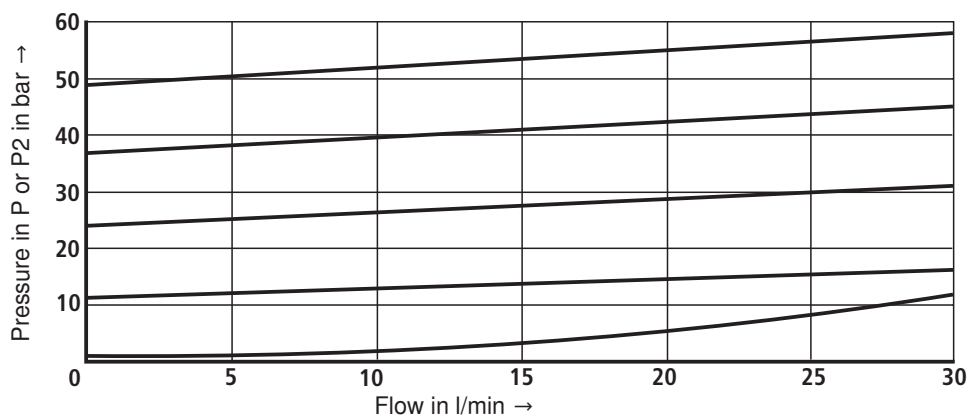

Pressure rating 100 bar

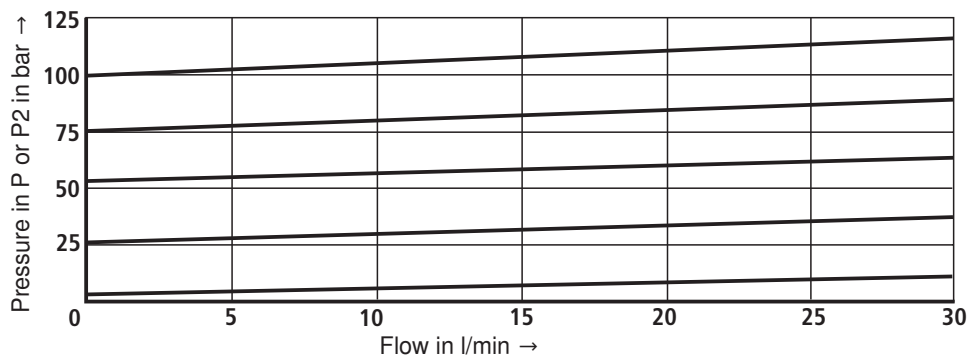

## Characteristic curves (measured with HLP 46; $\vartheta_{oil} = 40 \text{ °C} \pm 5 \text{ °C}$ )

### Pressure rating 200 bar

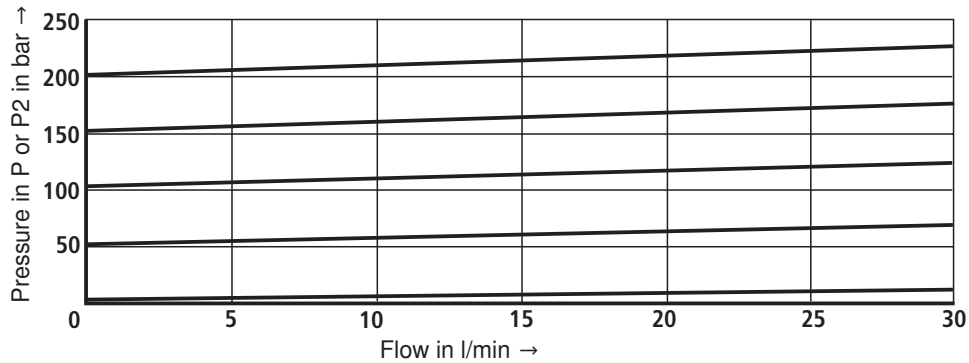

### Pressure rating 315 bar

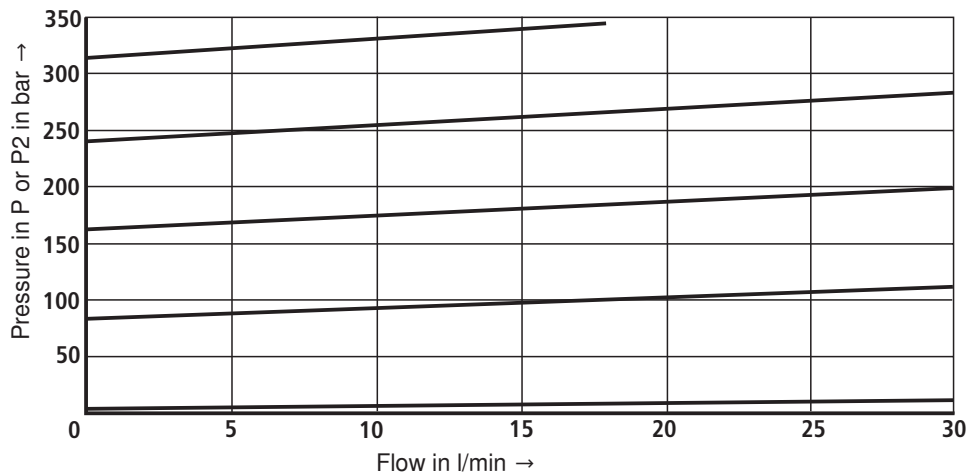

### Pressure rating 350 bar <sup>1)</sup>

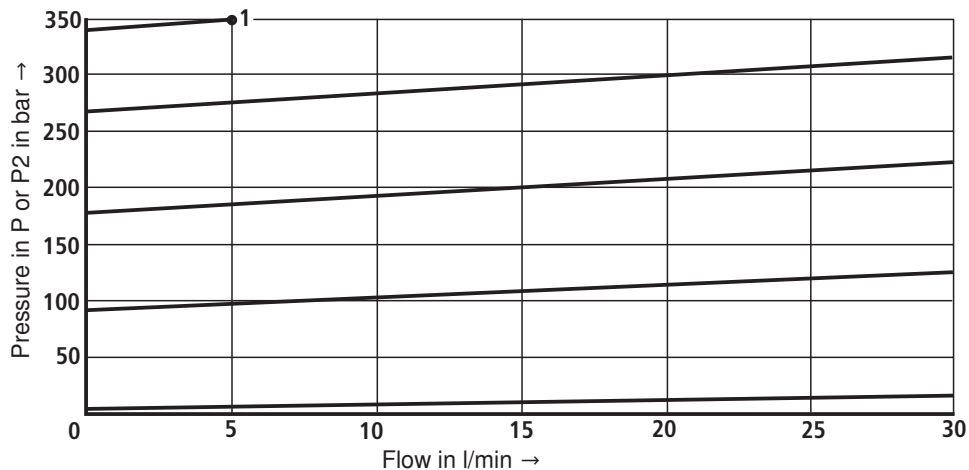

<sup>1)</sup> In case of characteristic curve 1, the command value may not exceed the maximum flow of 5 l/min

The characteristic curves were measured without counter pressure in port A (external pilot oil return) and T (internal pilot oil return). With internal pilot oil return, the pressure in P or P2 increases by the output pressure present in port T.

**Characteristic curves** (measured with HLP 46;  $\dot{v}_{oil} = 40 \text{ °C} \pm 5 \text{ °C}$ )

Min. setting pressure in port P or P2 or at command value 0.

Pressure rating 25 bar

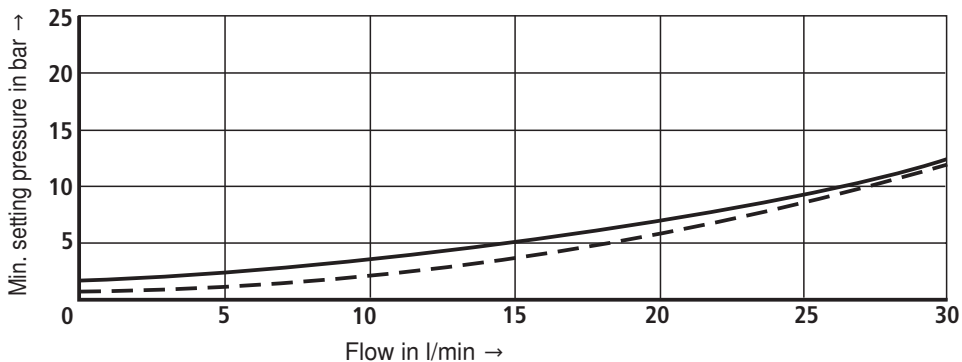

Pressure rating 50 bar

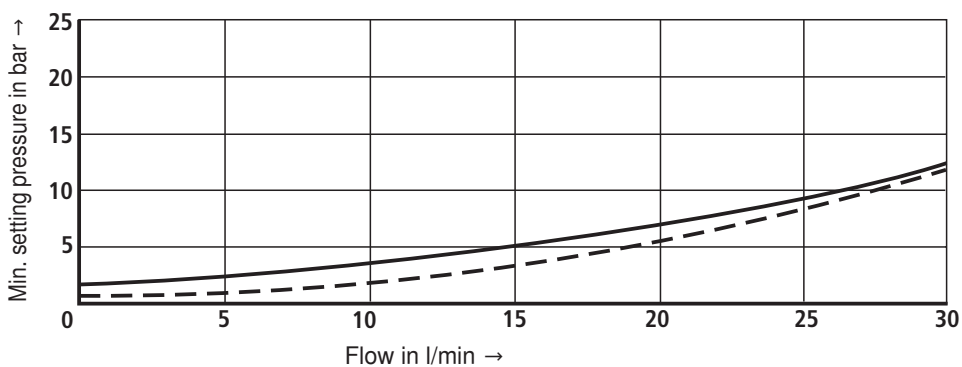

Pressure rating 100 bar

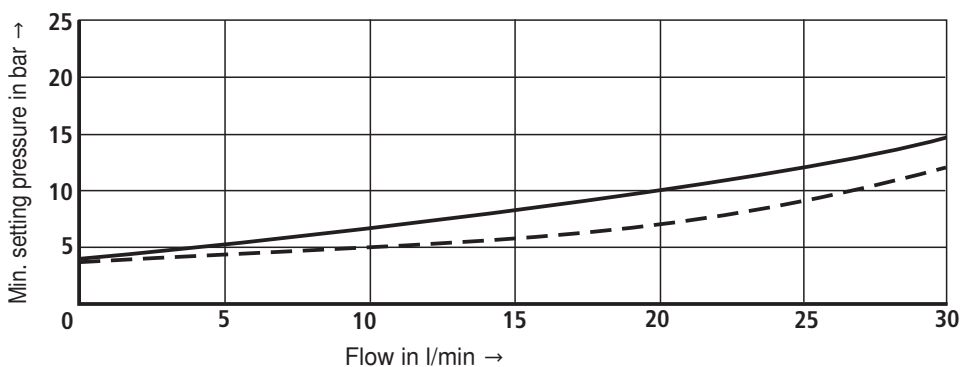

Pilot oil return    ——— Internal    - - - External

## Characteristic curves (measured with HLP 46; $\dot{v}_{oil} = 40 \text{ °C} \pm 5 \text{ °C}$ )

Pressure rating 200 bar

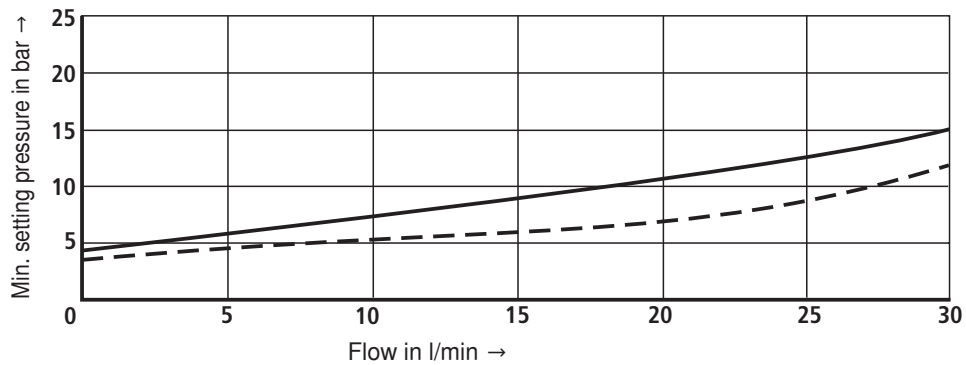

Pressure rating 315 bar

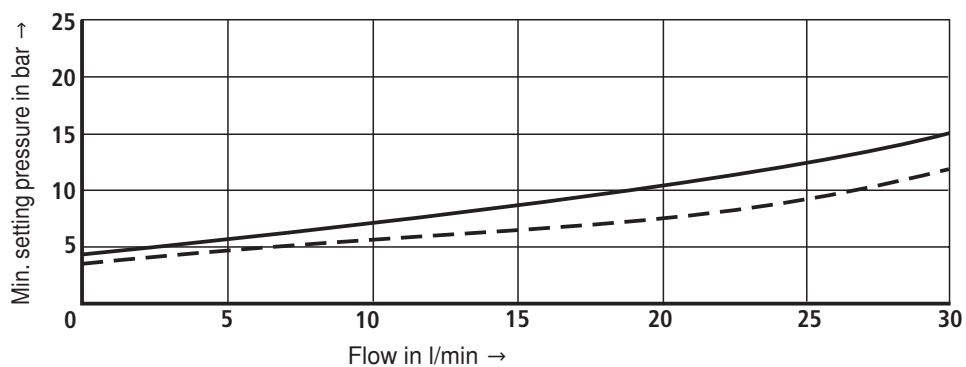

Pressure rating 350 bar

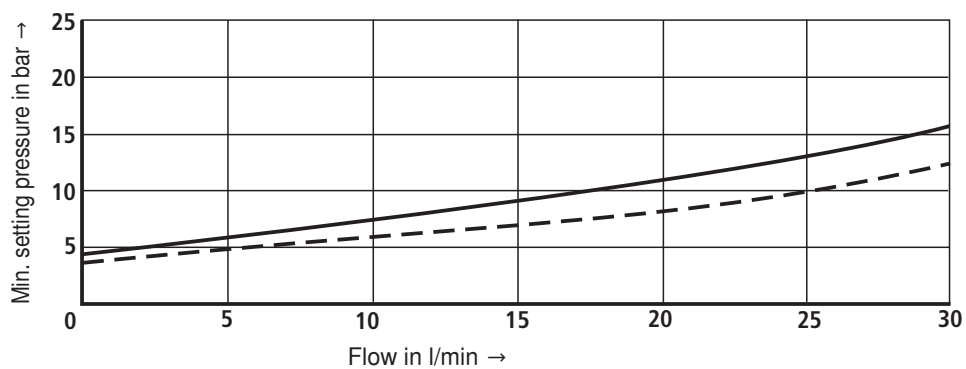

Pilot oil return    ——— Internal    - - - External

The characteristic curves were measured without counter pressure in port A (external pilot oil return) and T (internal pilot oil return). With internal pilot oil return, the pressure in P or P2 increases by the output pressure present in port T.

**Characteristic curves** (measured with HLP 46;  $\dot{v}_{oil} = 40 \text{ °C} \pm 5 \text{ °C}$ )

Pressure differential A1 → A2 and B1 → B2

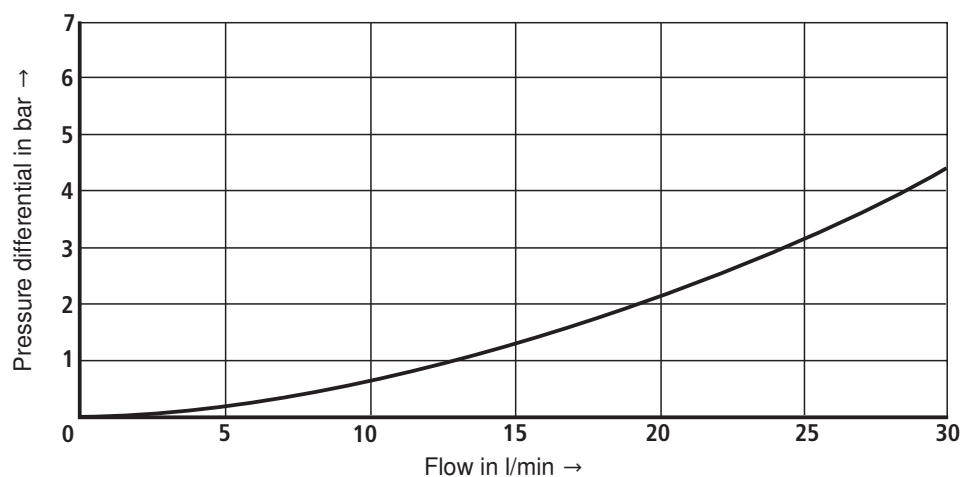

Pressure differential P1 → P2

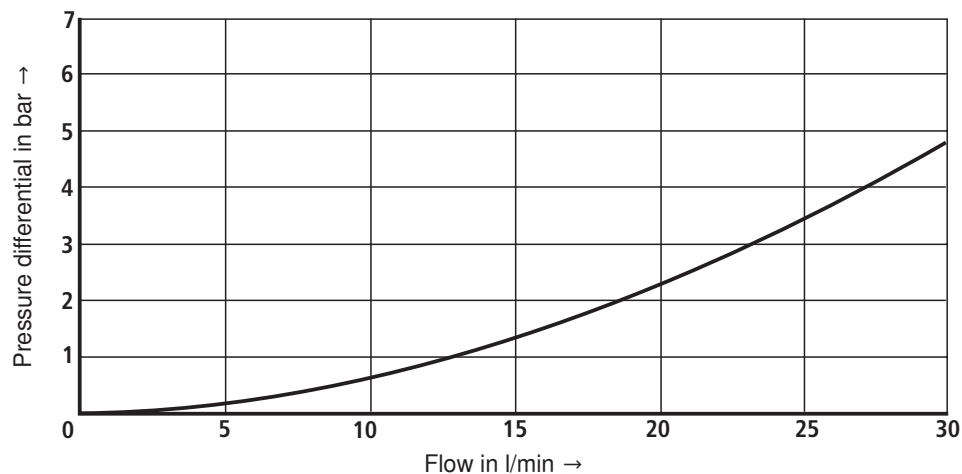

Pressure differential T1 → T2

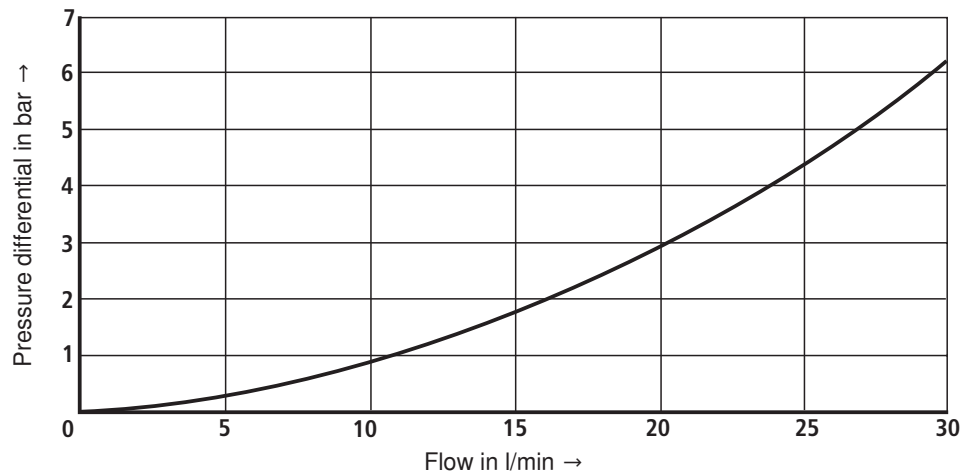



## Unit dimensions: Types DBE and DBEE (dimensions in mm)

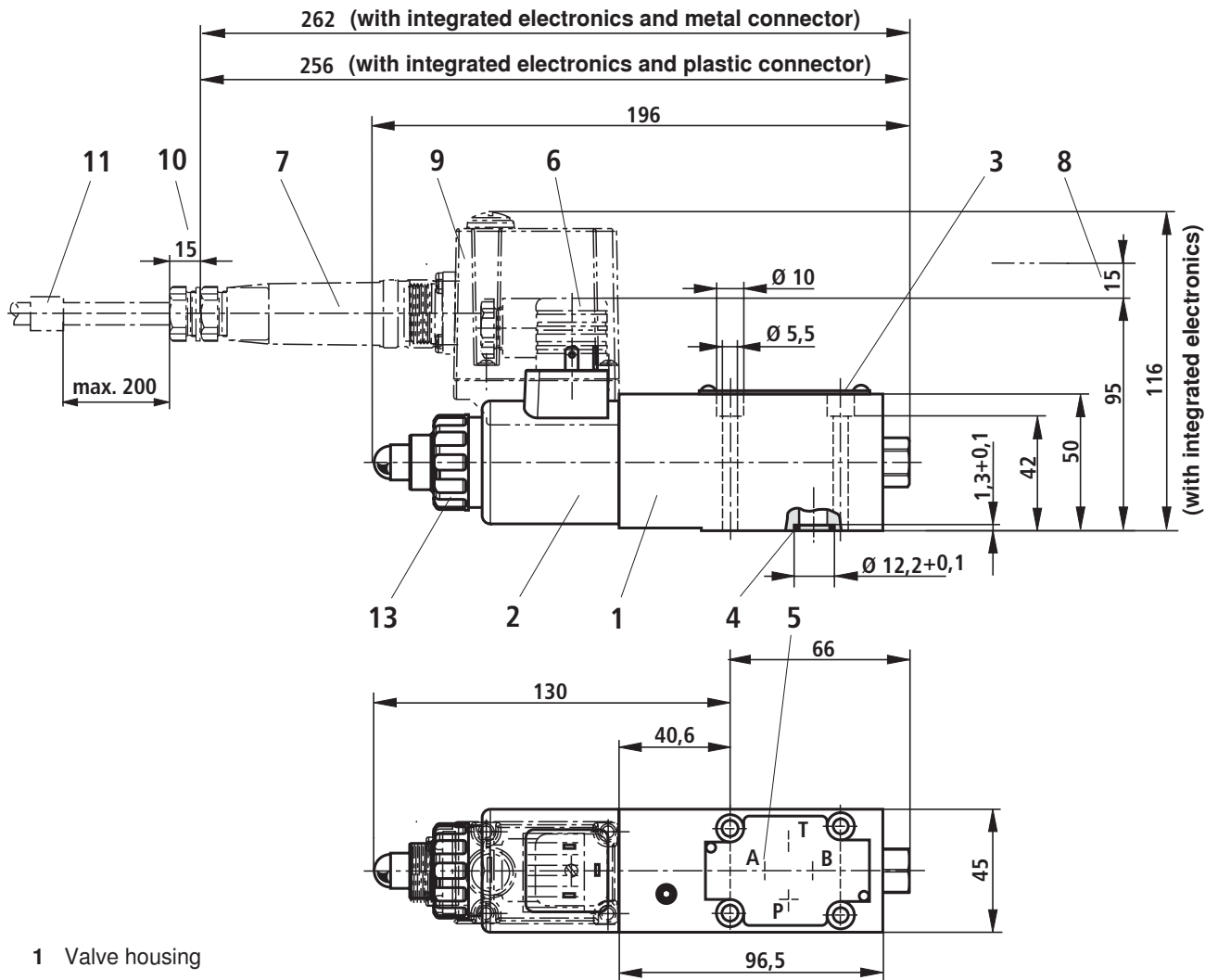

- 1 Valve housing
- 2 Proportional solenoid
- 3 Name plate
- 4 Identical seal rings for ports A, B, P, and T
- 5 With version Y, pilot oil return external via port A (Y)
- 6 Mating connector according to DIN EN 175301-803
- 7 Mating connector according to DIN EN 175201-804
- 8 Space required for removing the mating connector
- 9 Integrated electronics (OBE)
- 10 Space required for removing the mating connector
- 11 Cable fastening
- 12 Machined installation surface, porting pattern according to DIN 24340 (**without** locating hole) and ISO 4401-03-02-0-05 (**with** locating hole)
- 13 O-ring and plastic nut SW 32 for coil fixation  
The nut can be loosened by rotating it anticlockwise (1 turn). The solenoid coil can then be rotated to the required position before fixing it again by tightening the nut.  
Tightening torque: 4+1 Nm.

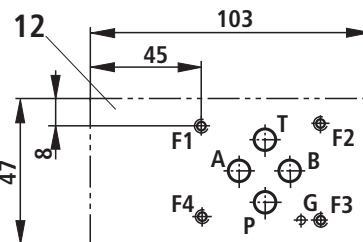

Required surface quality of the valve contact surface

**Tolerances according to:** – General tolerances ISO 2768-mK  
 – Tolerancing principle ISO 8015

Subplates and valve mounting screws see page 7

**Unit dimensions:** Types ZDBE and ZDBEE (dimensions in mm)

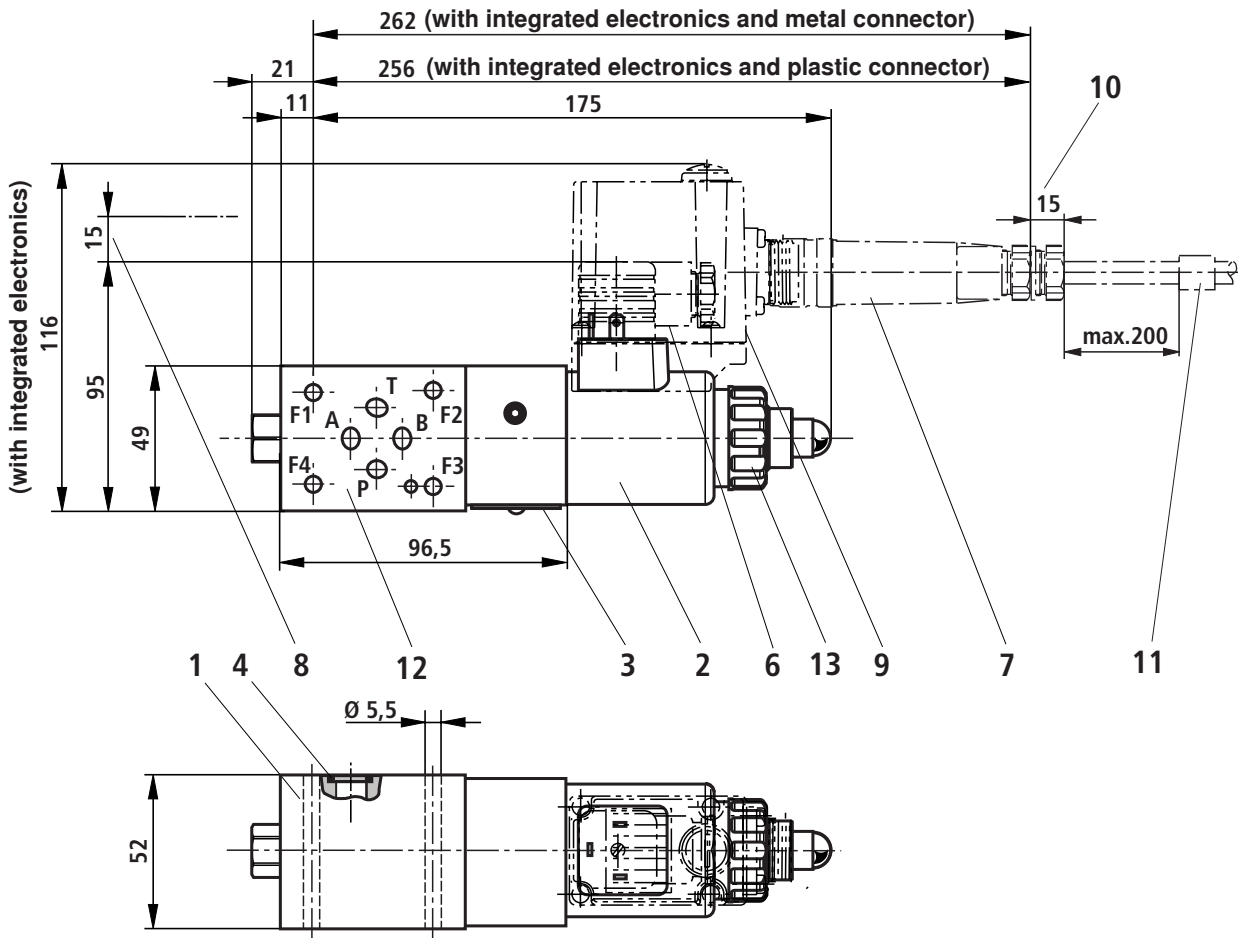

- 1 Valve housing
- 2 Proportional solenoid
- 3 Name plate
- 4 Identical seal rings for ports A, B, P, and T
- 6 Mating connector for type ZDBE  
(separate order, see page 6)
- 7 Mating connector for type ZDBEE  
(separate order see page 6)
- 8 Space required for removing the mating connector
- 9 Integrated electronics (OBE)
- 10 Space required for removing the mating connector
- 11 Cable fastening
- 12 Machined installation surface, porting pattern according to DIN 24340 (**without** locating hole) and ISO 4401-03-02-0-05 (**with** locating hole)
- 13 O-ring and plastic nut SW 32 for coil fixation  
The nut can be loosened by rotating it anticlockwise (1 turn). The solenoid coil can then be rotated to the required position before fixing it again by tightening the nut.  
Tightening torque: 4+1 Nm.

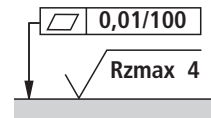

Required surface quality of the valve contact surface

**Tolerances according to:** – General tolerances ISO 2768-mK  
– Tolerancing principle ISO 8015

**Subplates and valve mounting screws see page 7**

## Notes

---

Bosch Rexroth AG  
Hydraulics  
Zum Eisengießer 1  
97816 Lohr am Main, Germany  
Phone +49 (0) 93 52 / 18-0  
Fax +49 (0) 93 52 / 18-23 58  
documentation@boschrexroth.de  
www.boschrexroth.de

© This document, as well as the data, specifications and other information set forth in it, are the exclusive property of Bosch Rexroth AG. It may not be reproduced or given to third parties without its consent. The data specified above only serve to describe the product. No statements concerning a certain condition or suitability for a certain application can be derived from our information. The information given does not release the user from the obligation of own judgment and verification. It must be remembered that our products are subject to a natural process of wear and aging.

Bosch Rexroth AG  
Hydraulics  
Zum Eisengießer 1  
97816 Lohr am Main, Germany  
Phone +49 (0) 93 52 / 18-0  
Fax +49 (0) 93 52 / 18-23 58  
documentation@boschrexroth.de  
www.boschrexroth.de

© This document, as well as the data, specifications and other information set forth in it, are the exclusive property of Bosch Rexroth AG. It may not be reproduced or given to third parties without its consent. The data specified above only serve to describe the product. No statements concerning a certain condition or suitability for a certain application can be derived from our information. The information given does not release the user from the obligation of own judgment and verification. It must be remembered that our products are subject to a natural process of wear and aging.